

pvlab **ROBOT**
CREME

MULTIFUNCTION
MF15T



TECHNOLOGY EMPOWERING YOUR CREATIVITY

One device with different functionalities:

PASTEURIZES

TURBINES

COOKS

COOLS

MIXES

EMULSIFIES

MULTIFUNCTION MF15T



Pasteurize



Batch Freezer



Cooks



Cools



Mixes



Emulsifies

- Electronic controls
- Bitzer semi-hermetic compressor
- Mixed or water condenser cooling
- Body in stainless steel AISI 304
- CFC-free polyurethane insulation
- R452a refrigerant gas
- Safety device to stop the agitator when the lid is opened
- Chaining program allowing : to put, (for example) the ingredients of a pastry cream in conservation all the night, which will start at the pre-set hour, so that the preparation is ready at the opening of the laboratory
- Possibility of 1/2 load in cold
- Direct extraction from the bottom of the tank
- Variable speed drive
- Defrosting of the tank by inversion of the hot gas cycle.
- Variotexture : acts directly on the frequency of the motor driving the mixing arm, allowing by a value index, the choice of the texture of your ice creams and sorbets

RECIPES TABLE

	Quantities		Duration (min)	
	mini	maxi	mini	maxi
Pastry cream	4,0 kg	14,0 kg	35	55
Butter Mouseline	2,1 kg	9,0 kg	12	20
Diplomatic cream	4,0 kg	14,0 kg	25	45
Lemon cream	3,0 kg	12,0 kg	30	50
Almond cream	2,0 kg	8,0 kg	30	55
Choux pastry	3,2 kg	13,0 kg	30	50
Ganache	3,0 kg	15,0 kg	20	40
Buttercream succes	2,0 kg	5,0 kg	25	45
Custard	4,0 kg	14,0 kg	25	50
Crème brûlée	3,2 kg	14,5 kg	25	45
Creamy fruit	1,9 kg	13,2 kg	25	45
Fruit bavarian Cream	2,5 kg	12,5 kg	25	40
Chocolate bavarian Cream	4,2 kg	12,8 kg	30	50
Brownies	1,6 kg	12,8 kg	10	30
Bomb paste	1,7 kg	4,0 kg	25	45
Fruit pastes	2,4 kg	6,8 kg	40	80
Jellies	2,0 kg	7,0 kg	35	85
Jams	2,0 kg	7,0 kg	50	90
Marshmallows	1,3 kg	2,6 kg	15	30
Pectin solution coating	3,0 kg	15,0 kg	30	85
Cold glaze	3,4 L	13,4 L	30	50
Glazes	3,4 L	6,9 L	30	60
Chocolate sauce	1,9 kg	14,8 kg	20	45
Ice cream	2,0 L	6,0 L	10	15
Sorbets	2,0 L	6,0 L	10	15
Pre-baked quiche maker	3,0 kg	15,0 kg	20	30
Béchamel sauce	2,6 kg	13,0 kg	30	45
Pasteurization	3 L	14 L	25	35

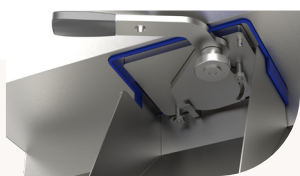

Extraction handle in closed position

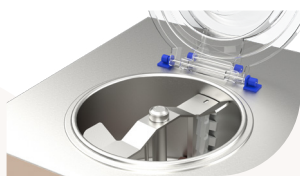

Open tank and mixing arm

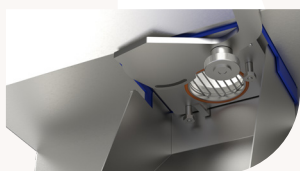

Extraction handle in open position

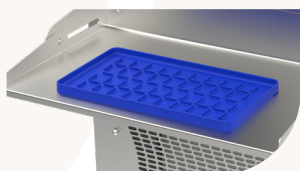

Pull-out and adjustable in four height levels

MIXING ARM

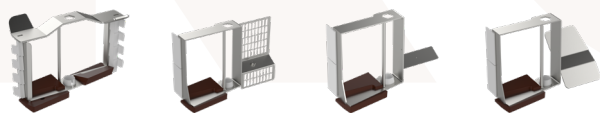

CONTROL PANEL

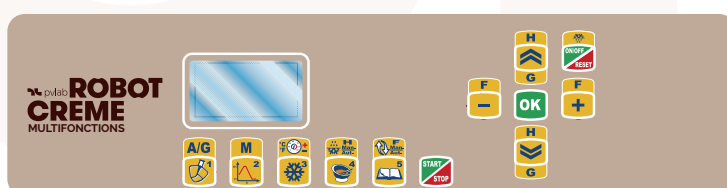

TECHNICAL DRAWING

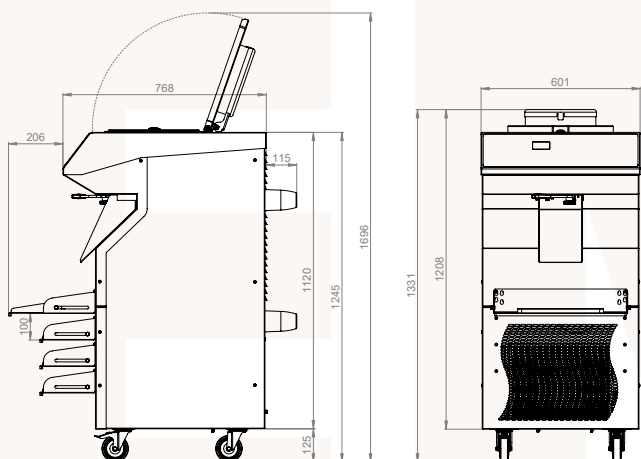

TECHNICAL DATA

Tank capacity	15L
Hourly ice cream production	60L/h
Min/max temperatures	-15/+110°C
Electrical power	6000W - 8,7A
Voltage and frequency	400V ~ 50Hz
Dimensions L x W x H	60,1 x 76,8 x 133,1 cm 169,6 cm (open lid)
Net weight	215 kg